



Facade systems

Technical specification

ExoTec[®] facade panel
and fixing system



James Hardie
A smarter way to build

AUSTRALIA JULY 2014

CONTENTS

1	APPLICATION AND SCOPE	2
1.1	Application	2
1.2	Scope	2
1.3	Specific design and detailing	2
2	DESIGN	3
2.1	Compliance	3
2.2	Slab and footings	3
2.3	Ground clearances	3
2.4	Coastal areas	3
2.5	Moisture management	3
2.6	Top hat framing	3
2.7	Fasteners spacings	4
3	SUBSTRUCTURE AND PREPARATION	5
3.1	Substructure	5
3.2	Membrane	5
3.3	Flashing	5
4	TOP HAT AND PANEL LAYOUT	5
4.1	General	5
4.2	Panel orientation	5
4.3	Panel layout	5
5	FIXING	5
5.1	General	5
5.2	Fastener durability	5
5.3	Countersunk fasteners	5
5.4	Exposed head fasteners	5
6	JOINTS	6
6.1	Panel joints	6
6.2	Vertical panel joints	6
6.3	Horizontal panel joints	6
6.4	Sealant filled joints	6
6.5	Panel joints in high wind load areas	6
6.6	Movement Joints	6
7	JUNCTIONS	7
7.1	Slab junctions	7
7.2	Soffit junction	7
8	CORNERS	7
9	WINDOWS	7
10	SPECIAL DETAILS	7
10.1	Curved facades	7
10.2	Parapet capping	8
10.3	Abutments	8
10.4	Inspection	8
11	FINISHES	8
11.1	General	8
11.2	Panels exposed to direct sunlight	8
12	PRODUCT INFORMATION	8
12.1	Material	8
12.2	Durability	8
12.3	Alpine regions	8
12.4	Resistance to fire	8
12.5	Warning	9
12.6	Storage and handling	9
12.7	Maintenance	9
13	ACCESSORIES	10
14	DETAILS	11
15	WARRANTY	19

MADE IN AUSTRALIA

1 APPLICATION AND SCOPE

1.1 APPLICATION

The James Hardie ExoTec® facade panel provides a durable, expressed joint panel appearance for building facades, fascias and soffits and together with the fixing system offers versatility to architects and builders. This is demonstrated by the variety of design styles that have been achieved including curved walls, panels installed vertically, horizontally or in a brick pattern. A wide range of decorative finishes can be used, from site-applied acrylic textures, to available factory-applied polyurethane plain colours and metallic finishes.

Both the 9mm and 12mm thick ExoTec facade panels may be used in wall facades, fascias and soffits.

If you are a specifier...

or other responsible party for a project, ensure the information in these specifications is appropriate for the application you are planning and that you undertake specific design and detailing for areas which fall outside the scope of these specifications.

If you are an installer...

Ensure that you follow the design, moisture management and associated details and material selection provided by the designer and the ExoTec facade panel and fixing system Installation Manual.

Make sure your information is up to date

When specifying or installing James Hardie products, ensure you have the current manual. Additional installation information, warranties and warnings are available at www.jameshardie.com.au or Ask James Hardie™ on 13 11 03.

1.2 SCOPE

This Technical Specification is intended for use by architects, designers and specifiers who may be involved with the specification of the ExoTec facade panel and fixing system. Further information relating to the installation of the ExoTec facade panel and fixing system is available in the ExoTec facade panel and fixing system Installation Manual.

This Technical Specification covers the use of the ExoTec facade panel and fixing system in a commercial facade application over steel girts, masonry and concrete walling. The Technical Specification also covers the use of the ExoTec facade panel and fixing system in a residential application over timber or steel framing. The ExoTec facade panel and fixing system can also provide an expressed joint panel appearance for building soffits.

All the information and details within both the James Hardie ExoTec facade panel and fixing system Technical Specification and the Installation Manual apply to both the 9mm and 12mm thick ExoTec facade panels. However, in curved facade walls only 9mm thick panels may be used depending on the curve radius, refer to Clause 10.1 for more information.

Both the 9mm and 12mm thick ExoTec facade panels may be used in wall facades, fascias and soffits.

1.3 SPECIFIC DESIGN AND DETAILING

For use of the ExoTec facade panel and fixing system outside this published scope, the designer, architect or engineer must undertake specific design. James Hardie will not be responsible or warrant this product installed outside the scope of this Technical Specification.

For advice on designs outside the above scope contact Ask James Hardie™ on 13 11 03.

All dimensions shown are in millimetres unless noted otherwise. All Australian Standards referenced in this manual are current edition and must be complied with.

2 DESIGN

2.1 COMPLIANCE

All design and construction must comply with the appropriate requirements of the current Building Code of Australia (BCA), regulations and standards.

2.2 SLAB AND FOOTINGS

The slab and footings on which the building is situated must be designed and certified by a qualified structural engineer according to all relevant codes, regulations and standards.

2.3 GROUND CLEARANCES

Install James Hardie external cladding with a minimum 150mm clearance to the earth on the exterior of the building or in accordance with local building codes if greater than 150mm is required. Also, maintain a minimum 50mm clearance between James Hardie external cladding and roofs, decks, paths, steps and driveways.

Adjacent finished grade must slope away from the building in accordance with local building codes, typically a minimum slope of 50mm minimum over the first metre.

Do not install external cladding in areas where it may remain in contact with standing water or debris.

2.4 COASTAL AREAS

In coastal areas located within 1km of the shoreline or large expanses of salt water (eg. Port Phillip Bay, Sydney Harbour east of the Spit and Harbour Bridges, Swan River wet of the Narrows Bridge), one of the following is required:

- All horizontal and vertical expressed joints must be filled with a suitable sealant, refer to the sealant filled joints section in this specification.
- Where both the horizontal and vertical expressed joints are not filled, the joints and panels must be washed down twice a year. On unprotected walls, rain will perform this washdown, but where walls are protected by soffits above, the washdown twice per year is a maintenance requirement.

2.5 MOISTURE MANAGEMENT

The ExoTec facade panel and fixing system acts as a weather shield. To achieve a particular level of weathertightness, the designer must determine the appropriate moisture management detailing for the project. The designer should consider the following matters when making that determination:

- It is the responsibility of the builders and designers to identify moisture related risks associated with any particular building design. It is the responsibility of the builder to ensure appropriate moisture management is provided during framed wall construction through effective use of flashings, sealants and vapour permeable membranes such as HardieWrap™ weather barrier, building wraps, vapour retarders and damp proof course. Before installing panels, all wall openings, penetrations, intersections, connections, window sills, heads and jambs must incorporate appropriate flashing and waterproofing. Materials, components and the installation practices that are used to manage moisture in framed wall construction must, at a minimum, comply with the requirements of relevant standards, building codes and the manufacturer's specifications.
- Sealant at sheet joints must be installed where detailed in this literature. For wind pressures up to 4.0kPa, see Clauses 6.2 and 6.3. For pressures including and above 4.0kPa, both vertical and horizontal joints must be sealant filled, see Clause 6.5. Refer to Clause 6.4 for suitable joint sealant. Where sealant is exposed, refer to the sealant manufacturer for durability information.
- For high walls it may be necessary to provide flashing to drain the facade at one or more intermediate levels.
- The installation of smoke, vermin and other barriers must not restrict moisture from reaching flashings.

For information on membrane refer to Clause 3.2 of this manual.

2.6 TOP HAT FRAMING

ExoTec facade panels must be fixed to ExoTec top hat and intermediate JH top hat sections which are installed vertically over steel, masonry or timber structures, See Figure 1. ExoTec top hat and intermediate JH top hat sections must not be installed horizontally. Ensure a planar fixing surface for ExoTec facade panels. The structure can either be straightened or packed out between the substructure and top hats. Packing out of top hats must be limited to 20mm maximum.

It is the responsibility of the project engineer to determine the appropriate wind pressures for the project and specify the fixing of the top hats to the structure. The engineer must limit the deflection of the supporting structure to span/250 for Serviceability Wind Load.

The nominal spacing between top hats is 605mm for a 1200mm wide panel and 455mm for a 900mm wide panel, ie top hats are required at panel edges and at intermediate spacings within the panels. The ExoTec top hats at panel edges have the legs facing out from the structure and at intermediate locations the intermediate JH top hat is used, with the legs fixed to the structure, see Figure 2.

The maximum spans and nominal spacings of ExoTec top hats and intermediate JH top hats for wall and soffit applications are provided in Tables 1 and 2 respectively, see page 4. For wall applications, the maximum cantilever distance of the top hats is one quarter of the single span shown in Table 1.

TABLE 1 - WALLS

WALLS - MAXIMUM EXOTEC TOP HAT AND INTERMEDIATE JH TOP HAT SPANS (mm) FOR ULTIMATE DESIGN WIND PRESSURES (9mm AND 12mm PANELS)											
SPAN TYPE	NOMINAL TOP HAT SPACING (mm)	DESIGN WIND PRESSURE (kPa)									
		1.0	1.5	2.0	2.5	3.0	3.5	4.0	5.0	6.0	7.0
Single span	450	1680	1470	1330	1240	1160	1110	1060	980	890	800
	600	1530	1330	1210	1120	1060	1010	N/A	N/A	N/A	N/A
2 span	450	2250	1970	1790	1660	1500	1380	1250	1080	950	830
	600	2050	1790	1620	1400	1250	1140	N/A	N/A	N/A	N/A
3 span continuous	450	2080	1810	1650	1530	1440	1350	1250	1080	950	830
	600	1890	1650	1500	1390	1250	1140	N/A	N/A	N/A	N/A

TABLE 2 - SOFFITS

SOFFITS - MAXIMUM EXOTEC TOP HAT AND INTERMEDIATE JH TOP HAT SPANS (mm) FOR ULTIMATE DESIGN WIND PRESSURES (9mm AND 12mm PANELS)											
SPAN TYPE	NOMINAL TOP HAT SPACING (mm)	DESIGN WIND PRESSURE (kPa)									
		1.0	1.5	2.0	2.5	3.0	3.5	4.0	5.0	6.0	7.0
Single span	450	1560	1390	1270	1190	1120	1070	1030	960	900	860
	600	1420	1260	1160	1080	1020	N/A	N/A	N/A	N/A	N/A
2 span	450	2090	1860	1710	1600	1440	1310	1210	1050	930	840
	600	1900	1690	1520	1340	1200	N/A	N/A	N/A	N/A	N/A
3 span continuous	450	1930	1720	1580	1470	1390	1310	1210	1050	930	840
	600	1750	1560	1430	1340	1200	N/A	N/A	N/A	N/A	N/A

2.7 FASTENER SPACINGS

Table 3 indicates the maximum fastener spacings at sheet edges and at intermediate JH top hats for wall and soffit applications.

TABLE 3 - WALLS & SOFFIT

FASTENERS SPACINGS (9mm AND 12mm THICK PANELS) FOR WALL AND SOFFIT APPLICATION			
Design wind pressure (ultimate) (kPa)	Nominal top hat spacing (mm)	Max. fasteners spacing at sheet edges	Max. fasteners spacing at intermediate top hats (mm)
1.0	600	600	600
1.5	600	600	600
2.0	600	400	400
2.5	600	400	400
3.0	*600	400	300
3.0	450	400	400
3.5	450	350	350
4.0	450	300	300
4.5	450	300	300
5.0	450	300	250
5.5	450	300	250
6.0	450	300	200
6.5	400	250	200
7.0	400	250	200

NOTES TO TABLES 1, 2 AND 3

- Top hat deflection for serviceability limit state design to AS 1170.2 is limited to span/250, except where * is shown it is span/180.
- Design wind pressures to be in accordance with AS 1170.2 for ultimate strength design.
- For permissible design wind pressure, divide the ultimate strength design wind pressures by 1.5.
- For higher design wind pressures (ultimate), contact the James Hardie technical team on 13 11 03.

3 SUBSTRUCTURE AND PREPARATION

3.1 SUBSTRUCTURE

The ExoTec top hat and intermediate JH top hat sections are installed vertically over steel girts, masonry, concrete walling and in residential applications over timber or steel framing. In a residential application, noggings between studs can be used as intermediate support for ExoTec top hat and intermediate JH top hat sections.

A qualified structural engineer must design the substructure and the connection between the substructure and the top hats.

3.2 HARDIEWRAP™ WEATHER BARRIER

HardieWrap™ weather barrier must be installed behind Exotec® Facade Panel and Fixing system in accordance with the AS/NZS 4200.2 'Pliable building membranes and underlays – Installation' and HardieWrap™ Technical Data Sheet.

HardieWrap™ weather barrier delivers a triplshield of protection to help against external weather penetration, internal condensation build-up and external heat penetration. Additionally, it enhances the wall thermal performance, please refer to www.jameshardie.com.au or www.accel.com.au for more information.

If using an alternate product in lieu of HardieWrap™ weather barrier, the designer must ensure that the product is fit for purpose and it has the following properties in accordance with AS/NZS 4200.1:

- Vapour barrier - low or medium
- Water barrier - high

In hot humid areas of Australia, HardieWrap™ weather barrier may not be suitable, refer to the building designer for a suitable membrane and Ask James Hardie® on 13 11 03.

Soft compressible insulation installed between the front of the wall studs and directly behind the external cladding can cause installation issues is thus not recommended.

3.3 FLASHING

All wall openings, penetrations, intersections, connections, window sills, heads and jambs must be flashed prior to top hat and sheet installation. Refer to Clause 2.5 for moisture management requirements.

3.4 THERMAL BREAK

The Building Code of Australia sections J1.5 and 3.12.1 volumes 1 and 2 respectively, state for both residential and commercial buildings a thermal break with an R 0.2m² K/W must be installed behind external cladding where the cladding and internal lining make direct contact with the same metal frame. For more information on the HardieBreak™ Thermal Strip, please refer to the installation manual at www.jameshardie.com.au

NOTE

The ExoTec façade panels are installed onto James Hardie™ top hat framing. It is recommended that you refer to the project certifier to determine if a thermal break is required. If required, it is recommend that the James Hardie™ HardieBreak™ thermal strip is installed vertically behind the top hats and in front of the HardieWrap™ weather barrier.

4 TOP HAT AND PANEL LAYOUT

4.1 GENERAL

The panel layout must be considered in conjunction with the building framing system, ie. the supporting top hat spacing must suit joints between panels and the design wind pressures, see Figure 1. Where construction joints occur in the structure, these must be carried through the top hats and panels, see Figure 9 and 12.

4.2 PANEL ORIENTATION

The panel must be installed with the distinctive white side facing the exterior of the structure. Where the back of the panel is open to the weather, refer to Clause 11.2 for specific requirements.

4.3 PANEL LAYOUT

Panels are generally installed with a 10mm nominal vertical and horizontal expressed joint between adjacent panels, ie for 1200mm wide sheets and 10mm panel joints the grid dimension is 1210mm, see Figure 1. Vertical joints up to 20mm width can be formed, with additional care required at installation to ensure the panel edges cover the ExoTec gasket snap strip on both sides of the joint. A minimum vertical expressed joint of 6mm is allowed with care.

The vertical expressed joints may also be aligned or offset in a brick pattern layout.

NOTES

Wherever feasible, use stock panel sizes to minimise site cutting. See Table 7.

5 FIXING

5.1 GENERAL

ExoTec panels must be fixed to ExoTec top hats and intermediate JH top hats with either:

1. Countersunk screws flush finished with epoxy then with James Hardie base coat. Generally used with site-applied acrylic coatings. Refer to 5.2, 5.3 and Figure 3.
2. Exposed head screws, e.g. pan, wafer and hex heads. Used where pre-finished panels are installed. Exposed head fasteners may be colour coated to match panel finish. Exotec facade washers are recommended to be inserted between the panel and the fastener. Refer to 5.2, 5.4 and Figure 4.

5.2 FASTENER

FASTENER SELECTION

ExoTec Facade panel and fixing system	Countersunk Fasteners	Exposed Head Fasteners
	Countersunk head self drilling screw No.10x30mm (Class 3 minimum coating)	Exposed pan, wafer or hex head self drilling screw No. 10x25mm (Class 3 minimum coating)

Fasteners must have the appropriate level of durability required for the intended project. Fasteners must be fully compatible with all other materials that it is in contact with to ensure the durability and integrity of assembly. Contact fastener manufacturers for more information.

This is of particular importance in coastal areas, subject to salt spray and other corrosive environments. For details on maximum fastener spacings to top hats for design wind pressures, see Table 3 and Figure 1.

For fastener installation refer to fastener fixing section in the ExoTec facade panel and fixing system Installation Manual.

5.3 COUNTERSUNK FASTENERS

Refer to 5.2 for fastener type. The screws are flush finished over with epoxy and then with James Hardie base coat. Use only proven epoxies for this application, ie Megapoxy P1 or Hilti CA 125. Where the temperature is below 15°C, use Hilti CA 273.

The screw head must be countersunk to a depth of 2.5mm to 3mm, see Figure 3.

5.4 EXPOSED HEAD FASTENERS

Refer to 5.2 for fastener type. ExoTec facade washers are recommended to be inserted between the panel and the fastener, see Figure 4.

ExoTec panels must be pre-drilled with a 6mm masonry drill, which provides a 6.2mm to 6.3mm diameter hole.

6 JOINTS

6.1 PANEL JOINTS

Panels are generally installed with a nominal 10mm wide expressed joint between adjacent panels, vertically and horizontally. Vertical joints to 20mm width can be formed with the ExoTec facade panel and fixing system, with additional care required at installation to ensure the panel edges cover the ExoTec gasket snap strip on both sides of the joint.

6.2 VERTICAL PANEL JOINTS

At vertical panel joints, prior to fixing panels, the ExoTec gasket snap strip is fitted into ExoTec top hats by starting at one end and pushing into the ExoTec top hat along its length. Ends of the snap strips are butted together in top hats without any need for sealant.

The ExoTec gasket snap strip is a hi-tensile roll-formed steel section with rubber gaskets built in. It provides a primary weather shield for a design wind up to 4.0kPa, see Figure 6.

Panel edges are fixed directly to the ExoTec top hat without the need for packing at intermediate JH top hats.

6.3 HORIZONTAL PANEL JOINTS

At horizontal panel joints, ExoTec backing strips are polyurethane sealant bonded to the back of panels to form a socket to which the next course of panels (or parapet capping) are fixed over, see Figure 7. The ExoTec backing strip is a 0.55mm base metal thickness (BMT) hi-tensile roll-formed steel section, with a pre-formed stop to keep it fitted against the back of the top edge of the lower panel.

6.4 SEALANT FILLED JOINTS

Where joints are required to be sealant filled, James Hardie Joint sealant and Bostik Seal 'n' flex are recommended. Where vertical joints are sealed, a bond breaker tape must be installed behind the sealant as outlined in Figure 8.

6.5 PANEL JOINTS IN HIGH WIND LOAD AREAS

For design wind pressures including and above 4.0kPa, horizontal and vertical joints must be continuously sealed with a joint sealant over a bond breaker tape. Refer to Clause 6.4 for suitable joint sealant.

NOTE

Refer to sealant manufacturers' instructions for application, safe use and clean up.

6.6 MOVEMENT JOINTS

6.6.1 General

Movement joints are required to limit or remove stresses from the panels. Movement joints are provided by the 10mm expressed or sealant filled joints at the perimeter of the panels.

6.6.2 Vertical structural joints

Vertical structural joints are required in the cladding to coincide with structural joints in the structure to accommodate the anticipated movement. The vertical structural joint is constructed as shown in Figure 9.

Vertical structural joints are also required where there is a discontinuity in the structure e.g. where two truss ends meet at a connection which allows movement.

For details of abutment to masonry walls see Figures 10 and 11.

6.6.3 Horizontal structural joints

Horizontal structural joints are required at slab level where the framing supporting the top hats moves with the creep deflection in the slab. See Figures 12, 13 and 14 for details which can cater for this deflection. See Table 4 for the required height of the flashing upstand.

NOTE

The project engineer is responsible for specifying the anticipated movement.

6.6.4 Construction joints

Refer to Clause 10.3 Abutments for finishing panels against an existing building or another cladding system.

7 JUNCTIONS

7.1 SLAB JUNCTIONS

7.1.1 Head

Where the cladding forms a junction with an exposed slab, the detail must provide for sufficient creep deflection in the slab. See Clause 6.6.3 for creep deflection where top hat crosses in front of the slab.

See Figure 15 for typical detail which can cater for this deflection.

7.1.2 Base

This junction can be treated in a number of ways, two of which are illustrated in Figures 16 and 17. See Table 4 for the required height of the flashing upstand.

TABLE 4

HEIGHT OF FLASHING UPSTAND						
Maximum design wind pressure (kPa ULS)	2.5	3.5	4.0	5.0	6.0	7.0
Minimum flashing upstand (mm)	150	200	250	300	350	400

NOTE

For permissible design wind pressure, divide ULS wind pressure by 1.5.

NOTE

It is essential that continuous flashing is provided behind the top hats at the base of walls to allow moisture to escape.

7.2 SOFFIT JUNCTION

There are many ways of detailing the soffit junction and it is important to ensure that a drip edge or groove is provided.

A typical approach on how to install the soffit fascia junction is shown in Figure 18. Ensure the ExoTec gasket snap strip is installed continuously to the bottom of the fascia panel.

NOTE

It is essential that continuous flashing is provided behind the top hats at the base of the fascia to allow moisture to escape. See Table 4 for required height of the flashing upstand.

8 CORNERS

Corners can be readily constructed using a folded corrosion resistant metal angle behind the ExoTec facade panels, to support the corners see Figures 19, 20 and 21.

If a corner with a small radius is required, it can be made in Glass Reinforced Cement (GRC), supplied by other.

NOTE

For ease of construction it may be preferred to fix the corner angle to one or both of the end top hats.

Figure 22 shows a typical external corner detail using Glass Reinforced Concrete (GRC) moulding.

9 WINDOWS

The ExoTec facade panel and fixing system provides an opportunity to consider a range of alternative window treatments. The building designer, in conjunction with the window manufacturer, must consider the adequate weatherproofing of the window application, see Clause 2.5. Typical window details are shown in Figures 23 to 25. See Table 4 for the required height of the flashing upstand.

10 SPECIAL DETAILS

10.1 CURVED FACADES

10.1.1 For radii 10m or greater

Where the curve radius is 10m or greater, 9mm thick panels are easily bent to the curve of the framing. Refer to Table 5 for maximum top hat spacing.

TABLE 5

MAX. TOP HAT SPACING FOR VARIOUS RADII		
RADII (m)	MAX. TOP HAT SPACING (mm)	
	900mm wide panels	1200mm wide panels
10 to 15	300	400
>15	450	To suit wind loading

NOTES

1. The closer the spacing of top hats, the less likely they will read through as facets in the panels, particularly at small radii.
2. 9mm thick panels may be able to be curved to a smaller radius, but this is likely to overstress panels.

NOTE

When fixing curved sheets, commence fixing from the centre ensuring full contact with top hats and work outwards to avoid “drumminess”. Particular care should be taken when curving panels to ensure the supports are on a true curve. If not, apart from poor appearance, there is a risk of locally over-stressing the panels and causing cracking.

Alternate materials and installation methods are available for radii less than specified above including glass reinforced cement (GRC) installed according to manufacturer’s specifications.

For further information on curved facades contact Ask James Hardie™ on 13 11 03.

10.2 PARAPET CAPPING

The design of the metal parapet capping should aim to minimise staining of the cladding, as follows:

1. Ensure the top of the capping has a slope towards the roof.
2. Provide a drip edge 30mm minimum out from the cladding face.
3. In addition, all joints in capping should be sealed. Figure 25 shows a typical design which meets these requirements. Refer to Table 6 for the required overlap.

TABLE 6

PARAPET CAPPING OVERLAP				
Maximum design wind pressure (kPa ULS)	1.5	3.5	5.0	7.0
Minimum capping overlap (mm)	50	100	150	200

NOTE

For permissible design wind pressure, divide ULS wind pressure by 1.5.

10.3 ABUTMENTS

There are numerous methods of finishing panels against another cladding system. Typical details are shown in Figures 26 and 27.

10.4 INSPECTION

After panels are installed and before painting, the facade/fascia should be inspected to ensure:

1. Required number and location of fixings are correct.
2. Sealant has been applied where specified. Particular attention should be given to the 3mm fillet of sealant between the backing strip and the panel along the full length of the horizontal backing strip socket.
3. The base coat applied over the epoxy and fastener has been sanded flush and smooth.
4. Minor damage to panel edges is filled, sanded smooth and painted as for cut edges, see Section 11.

11 FINISHES

11.1 GENERAL

To ensure the durability of ExoTec facade panels, as per Clause 12.2 the panels must be finished using one of the methods indicated below.

ExoTec facade panels will readily accept a wide variety of applied finishes, including site-applied textures and factory finishes.

For site-applied finishes (acrylic coatings), follow the paint manufacturer's recommended advice to adequately cover the sanded smooth fillers applied over the concealed fixings, see Clause 5.3.

In order to seal cut edges or sanded patches two coats of an appropriate primer should be applied at the time of cutting or sanding e.g. Dulux AcraPrime 501/1 (water based).

The face and edges of the panels must be coated in accordance with the paint manufacturer's recommendations and compatible with finish coatings.

For further information contact the service centre of the relevant paint company, as follows:

- Dulux Trade Customer Service on 13 23 77
- Taubmans Customer Service on 13 16 86
- Watty Hotline on 13 21 01

Polyurethane paints are not suitable as a site-applied finish but can be factory coated prior to installation. Pre-finished panels are generally installed using exposed head fasteners.

James Hardie does not recommend tiling in an external application.

11.2 UNFINISHED PANELS EXPOSED TO DIRECT SUNLIGHT

The unfinished panels must not be exposed to direct sunlight for any period greater than three months. The face and edges must be over-coated as recommended by the paint companies mentioned above. However, if the rear clear sealer is exposed to direct sunlight e.g. fascias, plantrooms, etc., then the clear sealer must be coated with a minimum of one coat of an exterior grade acrylic, pigmented white, with a minimum of 10 years warranty, by one of the paint companies previously mentioned.

It is the responsibility of the specifier to identify other weather related risks with any particular building design.

NOTE

Refer to paint manufacturer for paint specifications e.g. surface preparation, primer etc.

12 PRODUCT INFORMATION

12.1 MATERIAL

ExoTec facade panels are high quality compressed, autoclaved, cement based building panels manufactured by James Hardie. Basic composition is Portland cement, ground sand, cellulose fibre and water. Refer to Table 7 for ExoTec facade panel sizes.

James Hardie building products are manufactured to Australian/New Zealand Standard AS/NZS 2908.2 'Cellulose-Cement Products' (ISO 8336 'Fibre-Cement Flat Sheet').

ExoTec facade panel is classified Type A, Category 3 in accordance with AS/NZS 2908.2.

Refer to Table 7 for the nominal density of the ExoTec facade panel and panel sizes.

NOTE

9mm panel is the minimum thickness suitable for external wall applications.

12.2 DURABILITY

12.2.1 Resistance to moisture/rotting

ExoTec facade panel has demonstrated resistance to permanent moisture induced deterioration (rotting) by passing the following tests in accordance with AS/NZS 2908.2:

- Water permeability (Clause 8.2.2)
- Warm water (Clause 8.2.4)
- Heat rain (Clause 6.5)
- Soak dry (Clause 8.2.5)

12.2.2 Resistance to termite attack

Based on testing completed by CSIRO Division of Forest Products Report Numbers FP349 and FP274 James Hardie fibre cement has demonstrated resistance to termite attack.

12.3 ALPINE REGIONS

In regions subject to freeze/thaw conditions, all James Hardie fibre cement external cladding must be installed and painted in the warmer months of the year where the temperature does not create freeze and thaw conditions or paint issues. The cladding must be painted immediately after installation. In addition, fibre cement cladding must not be in direct contact with snow and/or ice build up for extended periods, e.g. external walls in alpine regions subject to snow drifts over winter.

Furthermore, a reputable paint manufacturer must be consulted in regards to a suitable product, specifications and warranty. The paint application must not be carried out if the air temperature or the substrate temperature is outside the paint manufacturer's recommendation including the specified drying temperature range

James Hardie external cladding products are tested for resistance to frost in accordance with AS/NZS 2908.2 Clause 8.2.3.

12.4 RESISTANCE TO FIRE

The ExoTec facade panels is suitable where non-combustible materials are required in accordance with C1.12 of the Building Code of Australia.

James Hardie building products have been tested by CSIRO in accordance with AS/NZS 3837 and are classified as conforming to Group 1 material (highest and best result possible), with an average specific extinction area far lower than the permissible 250m²/kg, as referenced in Specification C1.10a of the BCA."

12.4.2 Fire rated walls

Both one and two way fire rated wall systems are available with the ExoTec facade panel and fixing system. This will depend on the wall configuration and internal materials used. For more information refer to the ExoTec Facade Panel and fixing system FRL External Walls section of the James Hardie Fire and Acoustically rated walls application guide which is available at www.jameshardie.com.au, www.accel.com.au or Ask James Hardie™ on 13 11 03.

12.4.3 Fire protective

12mm thick ExoTec facade panel is suitable for use where the BCA requires the use of a fire protective material/lining (as deemed acceptable in the BCA Clause A1.1 Definitions – Fire Protective Covering).

12.5 WARNING - DO NOT BREATHE DUST AND CUT ONLY IN WELL VENTILATED AREA

James Hardie products contain respirable crystalline silica which is considered by some international authorities to be a cause of cancer from some occupational sources. Breathing excessive amounts of respirable silica dust can also cause a disabling and potentially fatal lung disease called silicosis, and has been linked with other diseases. Some studies suggest smoking may increase these risks. During installation or handling: (1) work in outdoor areas with ample ventilation; (2) minimise dust when cutting by using either 'score and snap' knife, fibre cement shears or, where not feasible, use a HardieBlade® saw blade and dust-reducing circular saw attached to a HEPA vacuum; (3) warn others in the immediate area to avoid breathing dust; (4) wear a properly-fitted, approved dust mask or respirator (e.g. P1 or P2) in accordance with applicable government regulations and manufacturer instructions to further limit respirable silica exposures. During clean-up, use HEPA vacuums or wet cleanup methods - never dry sweep. For further information, refer to our installation instructions and Material Safety Data Sheets available at www.jameshardie.com.au. FAILURE TO ADHERE TO OUR WARNINGS, MATERIAL SAFETY DATA SHEETS, AND INSTALLATION INSTRUCTIONS MAY LEAD TO SERIOUS PERSONAL INJURY OR DEATH.

12.6 STORAGE AND HANDLING

To avoid damage, all materials should be stored with edges and corners of the panels protected from chipping.

Panels must be protected from rain during transport and storage. Panels must be laid flat undercover on a smooth level surface clear of the ground to avoid exposure to water or moisture etc. ExoTec facade panels are resistant to permanent water damage when installed as directed, and must only be installed in a dry state.

When handling ExoTec facade panels, carry panels on the edge taking care not to chip edges and corners.

Refer to the current installation manual for recommended safe working practices.

12.7 MAINTENANCE

It is the responsibility of the specifier to determine normal maintenance requirements.

The extent and nature of maintenance will depend on the geographical location and exposure of the building. As a guide, it is recommended that basic normal maintenance tasks shall include but not be limited to:

- In coastal areas, a six monthly washdown of expressed joints must be done as per Clause 2.4.
- Annual checks and maintenance for the exposed sealant (3mm fillet at horizontal joints, filled vertical and horizontal joints) referenced in Clauses 6.2, 6.3, 6.4, 6.5, 6.6, 7.1, 9, 11.1 and 11.2, must be done as required by the sealant manufacturer.
- Maintenance to painted surfaces must be carried in accordance with the paint manufacturer's specification, see Clause 11.
- As required, clear debris build up against ExoTec facade panels.
- Maintain sealant as per manufacturer recommendations, to ensure weather seal.
- Clean out gutters, blocked pipes and overflows as required.





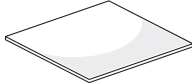

13 ACCESSORIES

EXOTEC FAÇADE PANEL INFORMATION

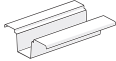
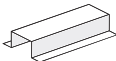
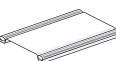
PRODUCT	DESCRIPTION	QUANTITY / SIZE (NOMINAL)		
		Thickness	Width	Lengths
			ExoTec facade panel Dense compressed panel. Square edge. Factory sealed on all six sides. Each panel has a distinctive white face, which accepts a wide range of paint finishes. The panel must be installed with the white side facing the exterior of the structure. Nom. density: 1550kg/m ³	9mm 12mm



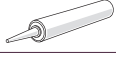
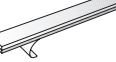
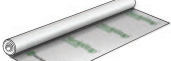



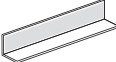

NOTE: Not all combinations of thicknesses, width and length are available ex stock, but are available to order. Check with James Hardie for availability of panel sizes.

PRODUCT / ACCESSORIES / TOOLS SUPPLIED BY JAMES HARDIE

ACCESSORIES	DESCRIPTION	QUANTITY/SIZE (APPROX)
	ExoTec® Top Hat A rolled metal section, for use with Exotec® façade panel and fixing system, designed to span vertically across the building structure to support façade panels and isolate differential movement of the panels from those of the structure. 124mm wide x 35mm deep x 1.15mm gauge thick. (Approximately)	45 per pack 6,000mm (304572) 7,200mm (304571)
	James Hardie™ Intermediate Top Hat A metal top hat installed vertically for use with ExoTec® and ComTex® façade panel and fixing system, for intermediate sheet support. 50mm wide x 35mm deep x 1.15mm gauge thick. (Approximately)	50 per pack 6,000mm (302701) 7,200mm (302700)
	Exotec® Gasket Snap Strip. 3,620mm long For use with the ExoTec® façade panel and fixing system, this gasket snap strip is specially designed to clip into the ExoTec® Top Hat at vertical façade panel joints to cover fixings to the structure and to provide an initial weather seal and drainage using a neoprene gasket.	10 per pack (305556)
	James Hardie™ Backing Strip. 1,190mm, 2390mm, 2990mm A weather seal at horizontal panel joints for use with ExoTec® façade panel and fixing system and Scyon™ Matrix™ cladding.	10 per pack 1,190mm (305557) 2,390mm (305558) 2,990mm (305559)
	James Hardie™ Façade Washers Façade washers used for exposed fastener fixing with ExoTec® façade panel and fixing system and Scyon™ Matrix™ cladding.	1000 per bag (305565)
	James Hardie™ Base Coat. 4kg tub, 15kg bag A water-resistant base coat compound used to finish over countersunk fasteners with epoxy.	4 per box - 4kg, 1 each - 15kg 4kg tub (305535) 15kg bag (305591)
	James Hardie™ Joint Sealant, 300ml cartridge A general purpose, paintable, exterior grade polyurethane joint sealant.	20 per box (305534)
	HardieBreak™ thermal strip A building code requirement and is installed behind James Hardie external cladding over metal framing and HardieWrap™ weather barrier. Refer to HardieBreak™ thermal strip installation guide. Unit size 43 x 12 x 2750mm.	45 per pack (305612)
	HardieWrap™ weather barrier A non-perforated, highly breathable and reflective safe-glare weather barrier designed to be used behind ExoTec® facade panel and fixing system to help protect the building. Unit size 2750mm x 30000mm.	1 Each (305664)
TOOLS		
	HardieBlade™ Saw Blade. 185mm diameter A 185mm diameter poly-diamond blade for fast and clean cutting of James Hardie fibre cement.	1 Each (300660)

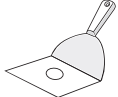
PRODUCT / ACCESSORIES / TOOLS NOT SUPPLIED BY JAMES HARDIE

James Hardie recommends the following products for use in conjunction with ExoTec facade system. James Hardie does not supply these products and does not provide a warranty for their use. Please contact the component manufacturer for information on their warranties and further information on their products.

ACCESSORIES	DESCRIPTION	ACCESSORIES	DESCRIPTION
	Miscellaneous light gauge pressed metal section Sections 1mm minimum to 1.2mm maximum corrosion resistant metal. Used in internal and external corner details.		Epoxy flush sealing (2 part) Countersunk head screws are flush sealed using mexapoxy P1 or Hilti CA 125. Where the temperature is below 15° use Hilti CA 273.
	Bond breaker tape Used when filling vertical joints to prevent sealant from bonding to top hat. Refer to the ExoTec facade panel and fixing system Technical Specification for suitable sealant.		Cordless drill Recommended tool for drilling holes and fastening screws.
	6mm masonry drill Provides a 6.2mm to 6.3mm diameter hole. Used to pre-drill clearance holes for fasteners.		Base coat applicator A recommended method of applying James Hardie™ base coat over epoxy filled countersunk screw heads. This method minimises waste. Base coat is easily sanded by comparison to epoxy fillers.
	Countersunk head drill 6mm countersunk bit.		Flexible tape A flexible self-adhesive tape used in preparation of a window. Refer to the window installation section in this Technical Specification for more information.
FASTENERS			
	Countersunk fasteners No. 10x30 countersunk head self drilling screws - Class 3 minimum coating. Fasteners must have the appropriate level of durability required for the intended project. Fasteners must be fully compatible with all other material that it is in contact with to ensure the durability and integrity of assembly. Contact fastener manufacturers for more information.		Exposed head fasteners No. 10x25mm pan, wafer or hex head self drilling screws Class 3 Minimum coating. Fasteners must have the appropriate level of durability required for the intended project. Fasteners must be fully compatible with all other material that it is in contact with to ensure the durability and integrity of assembly. Contact fastener manufacturer for more information.

14 DETAILS

Various details outlined below are available on pages 11-18. These details are also available in CAD format at www.accel.com.au

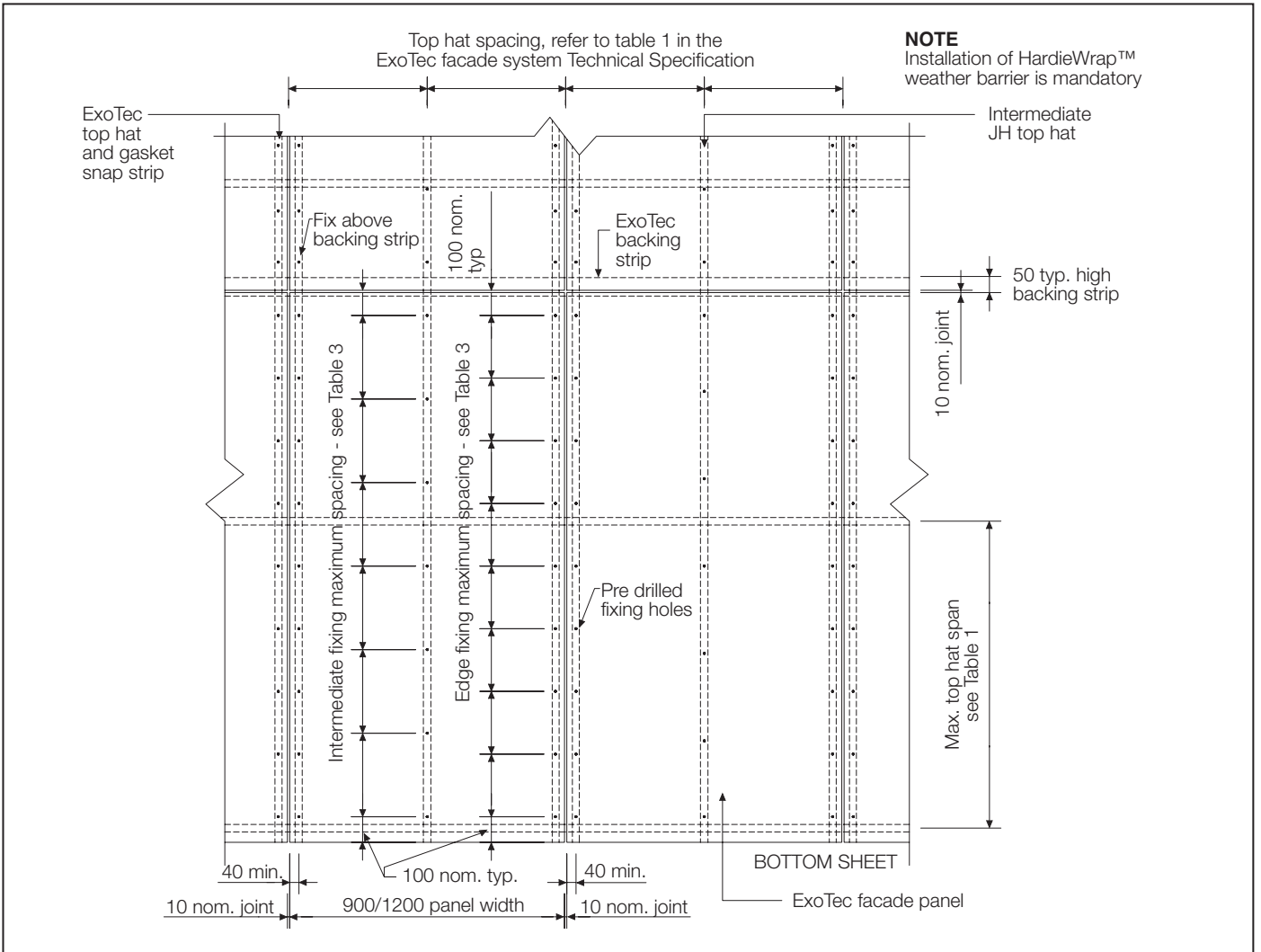

FIGURE 1 TYPICAL PANEL AND FRAMING LAYOUT

NOTE

Installation of HardieWrap™ weather barrier is mandatory

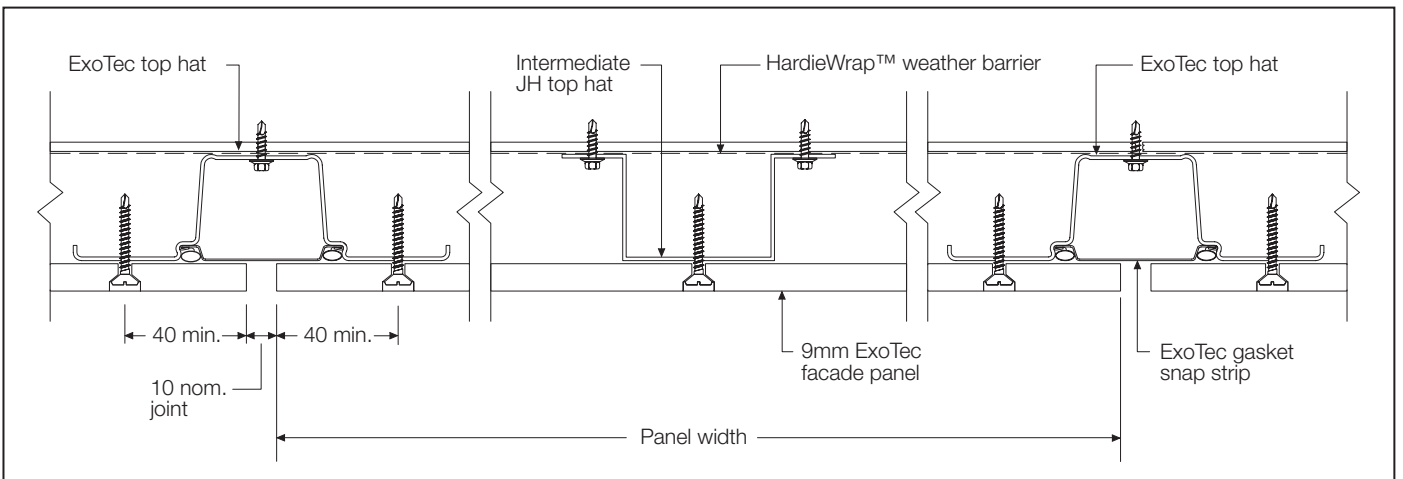

FIGURE 2 TOP HAT AND PANEL FIXING DETAIL

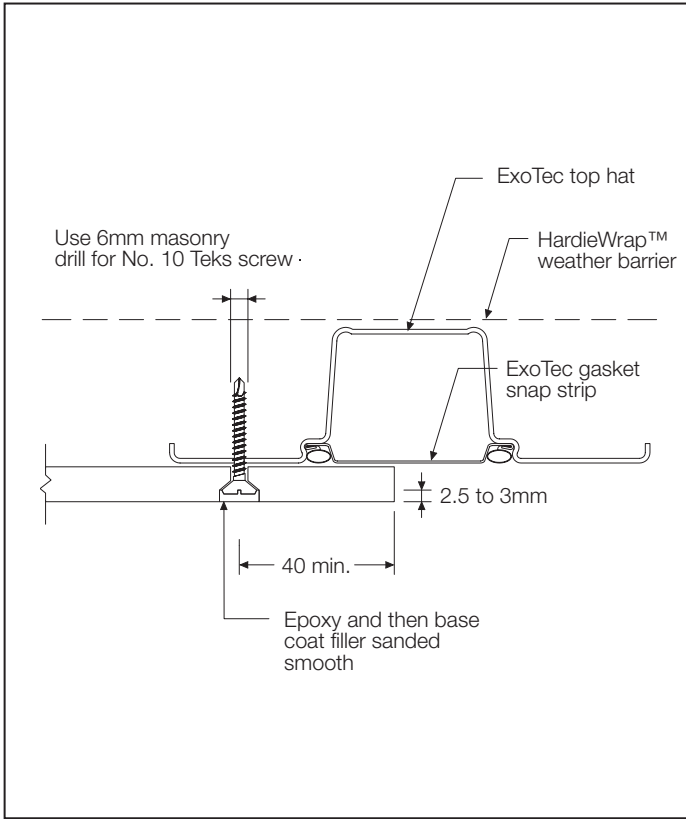

FIGURE 3 COUNTERSUNK FASTENER DETAIL

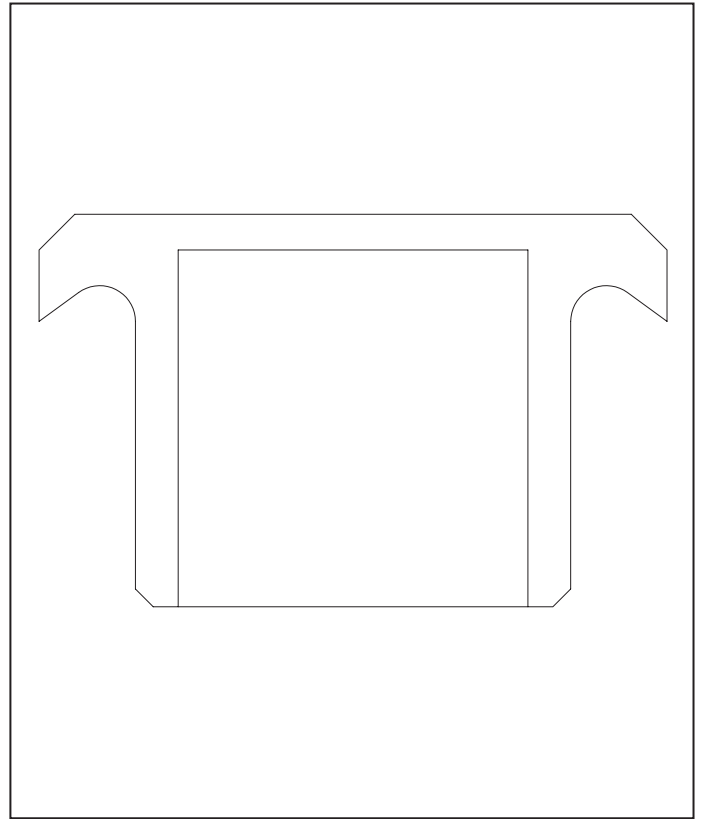

FIGURE 5 EXOTEC FACADE WASHER

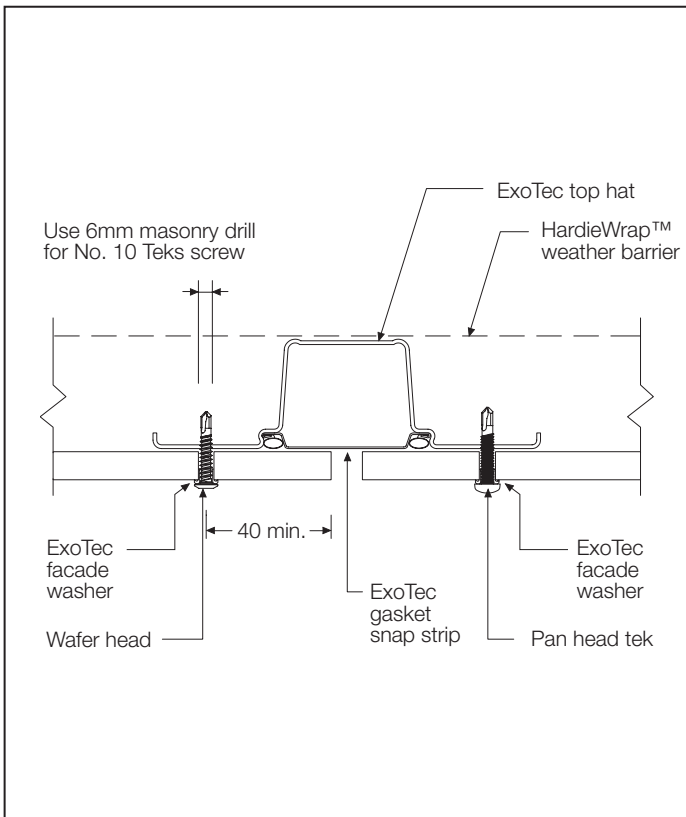

FIGURE 4 EXPOSED HEAD FASTENER DETAIL

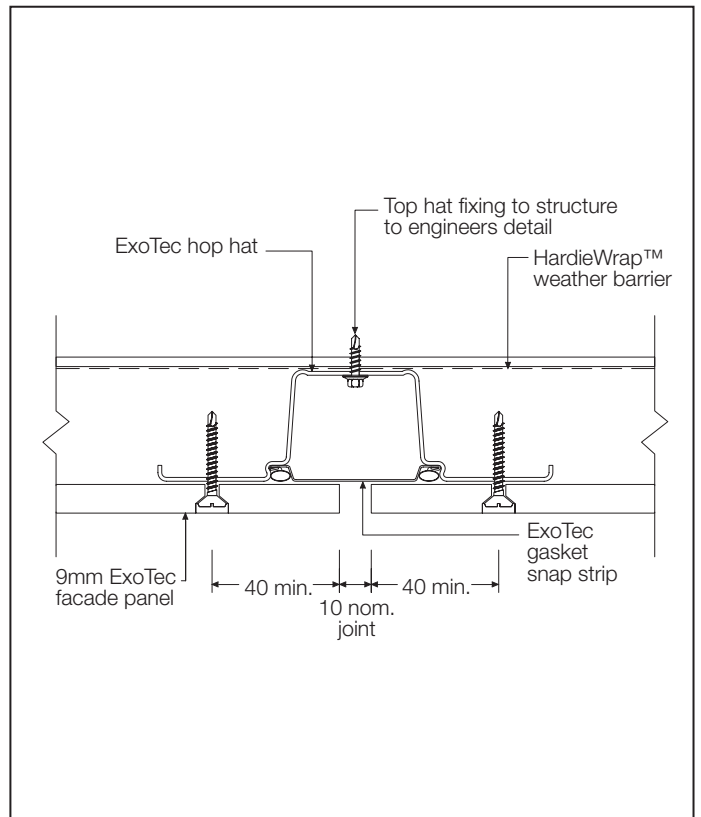

FIGURE 6 VERTICAL PANEL JOINT DETAIL

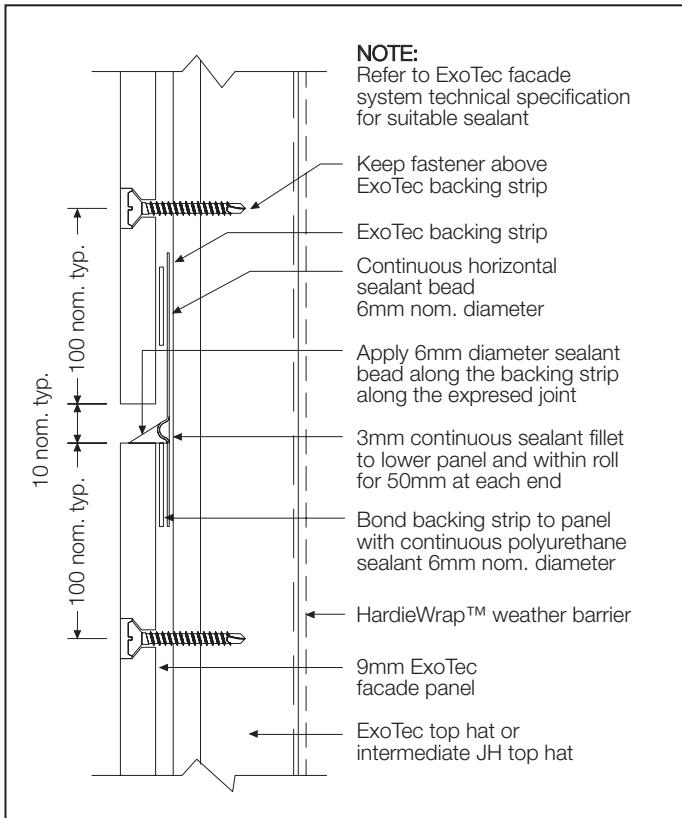

FIGURE 7 HORIZONTAL PANEL JOINT DETAIL

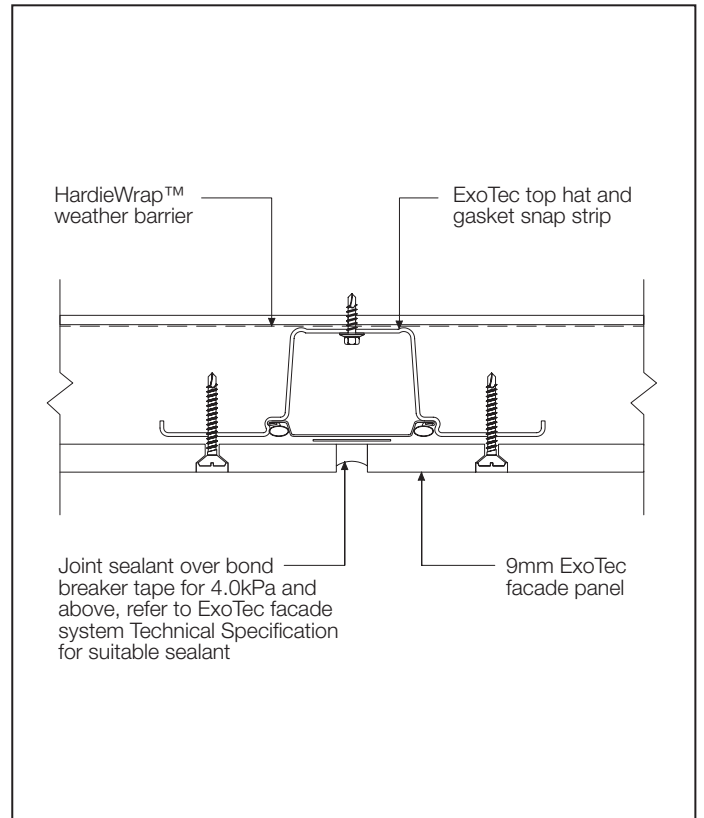

FIGURE 8 PANEL JOINTS IN HIGH WIND LOAD AREAS DETAIL

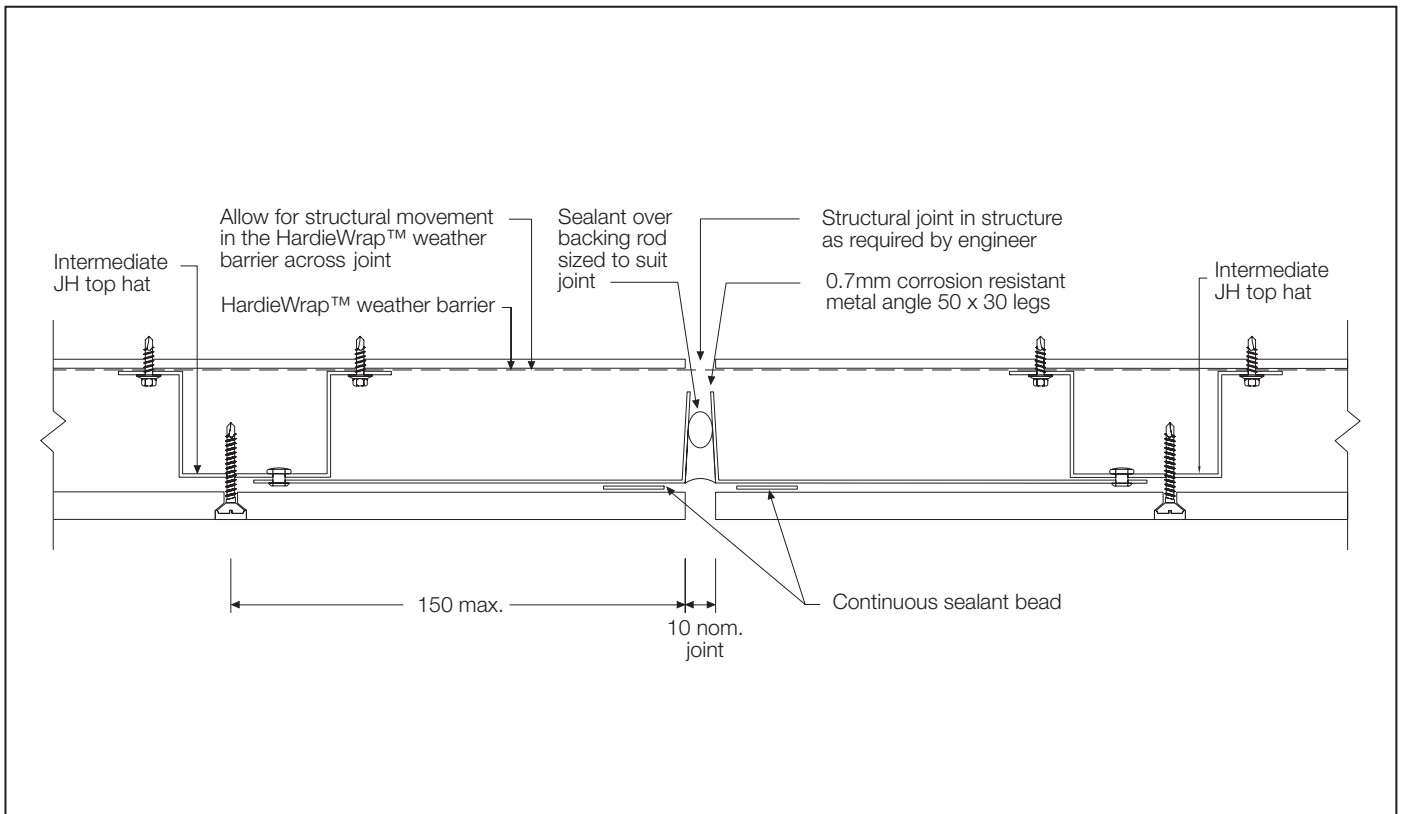

FIGURE 9 VERTICAL STRUCTURAL JOINT DETAIL

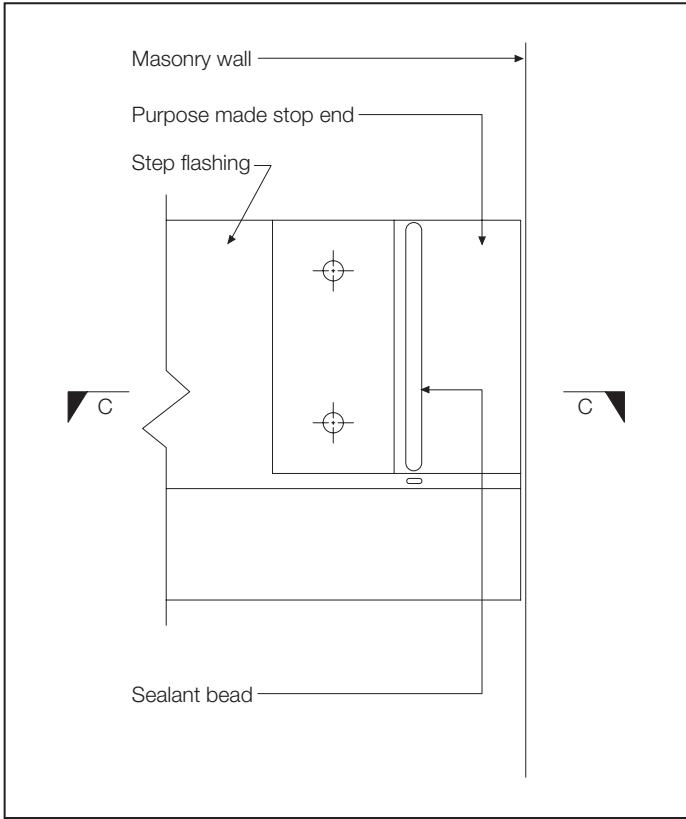

FIGURE 10 ELEVATION - STEP FLASHING INTO MASONRY WALL

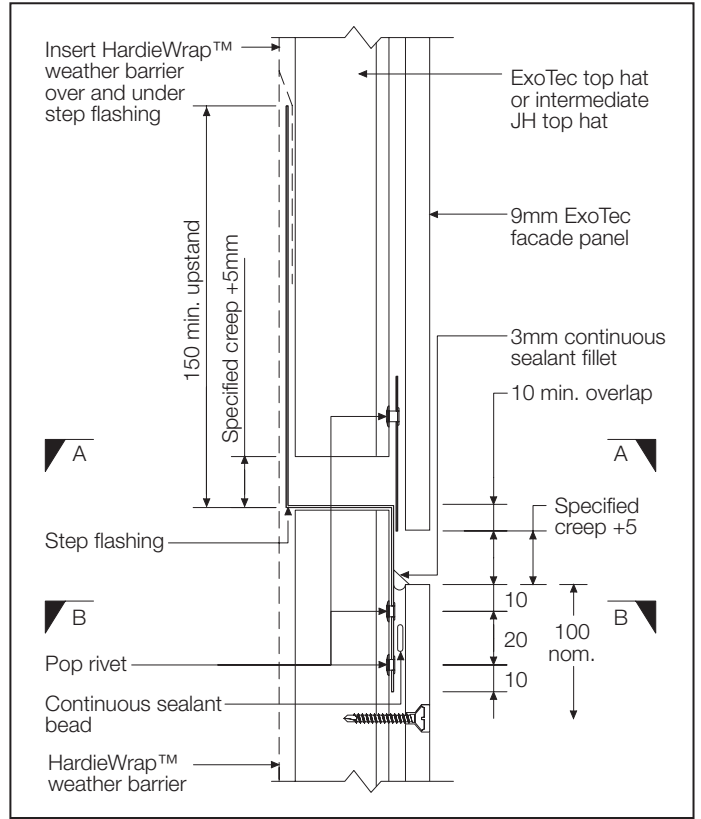

FIGURE 12 HORIZONTAL STRUCTURAL JOINT DETAIL

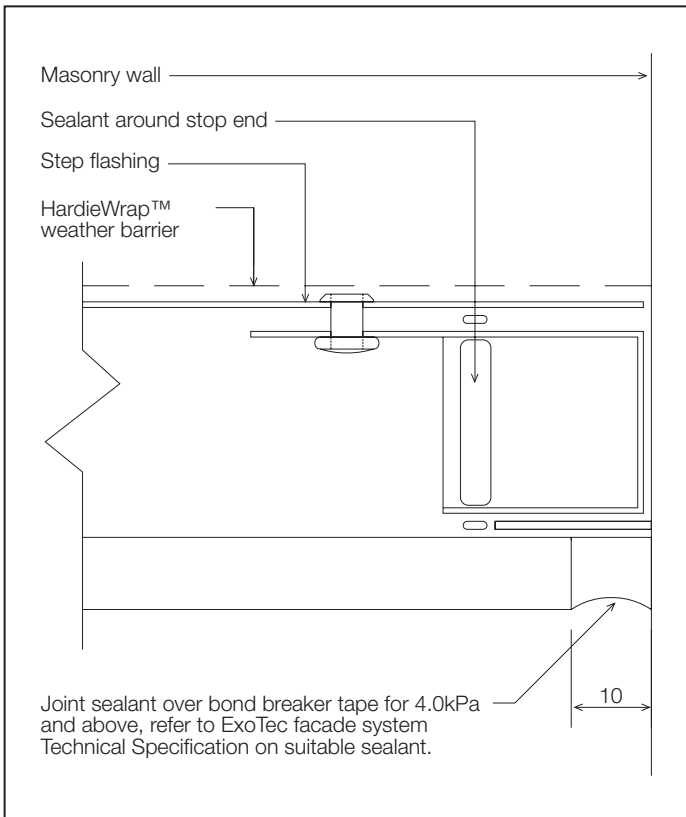

FIGURE 11 SECTION CC

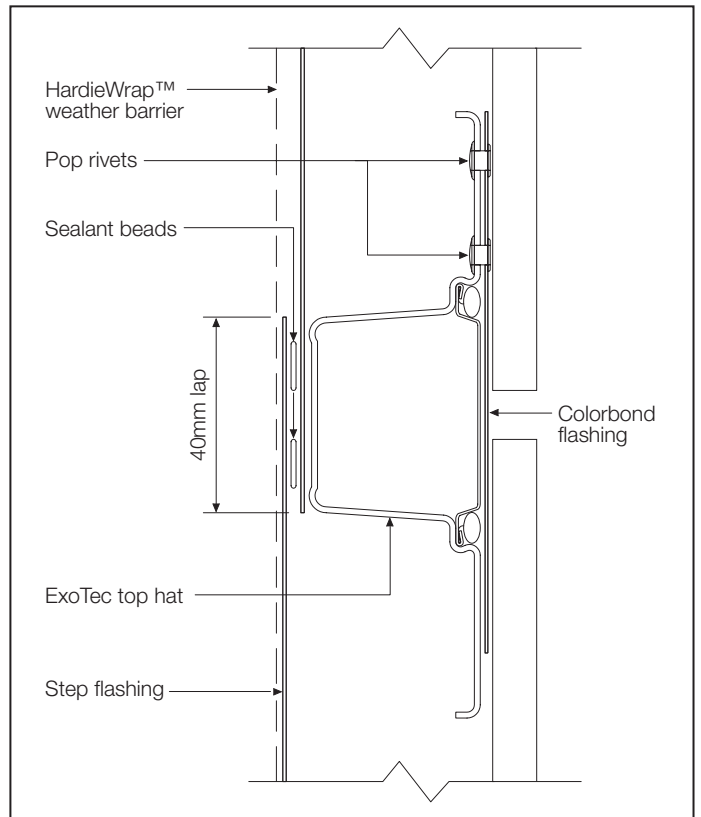

FIGURE 13 SECTION AA

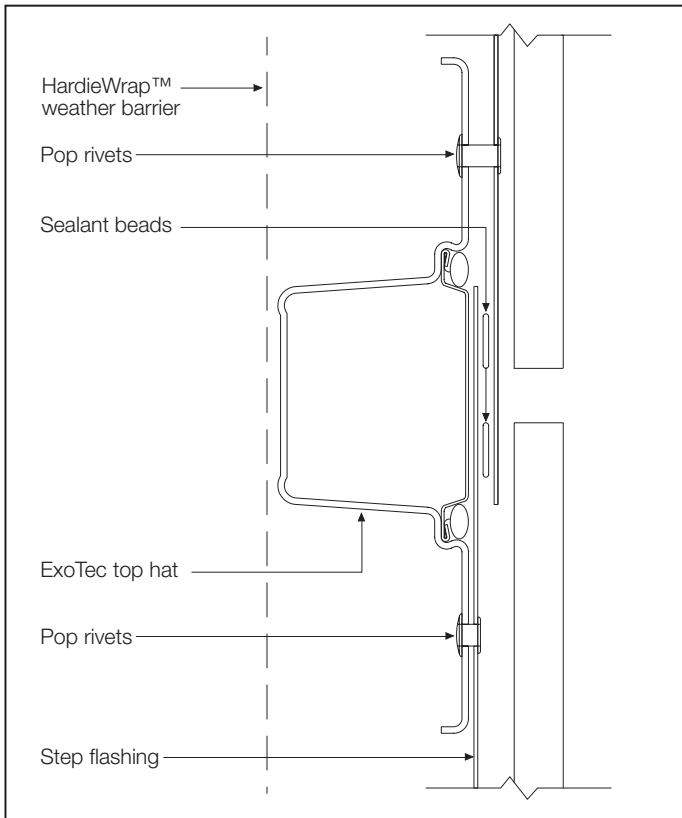

FIGURE 14 SECTION BB

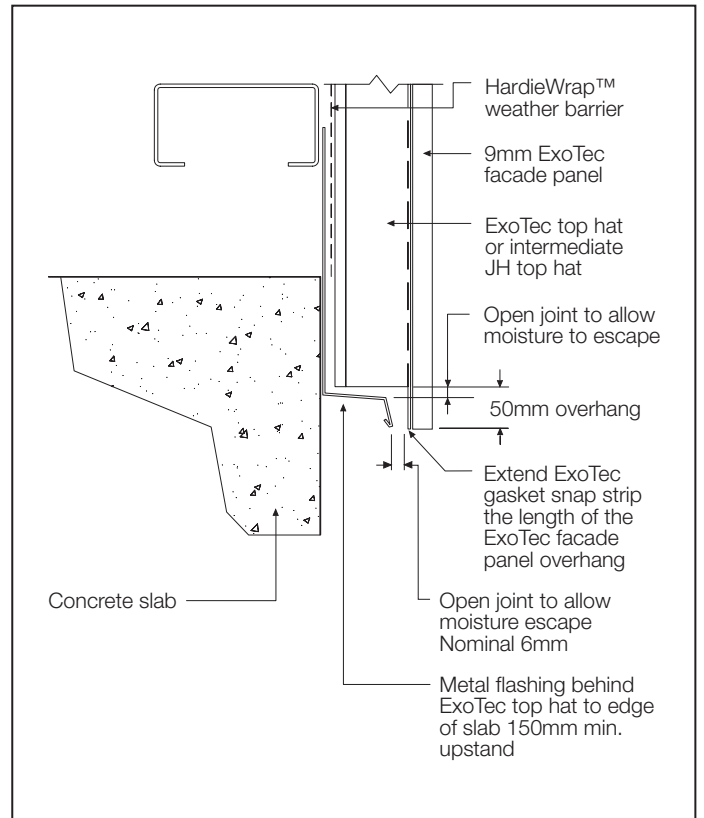

FIGURE 16 WALL BASE TYPICAL DETAIL 1

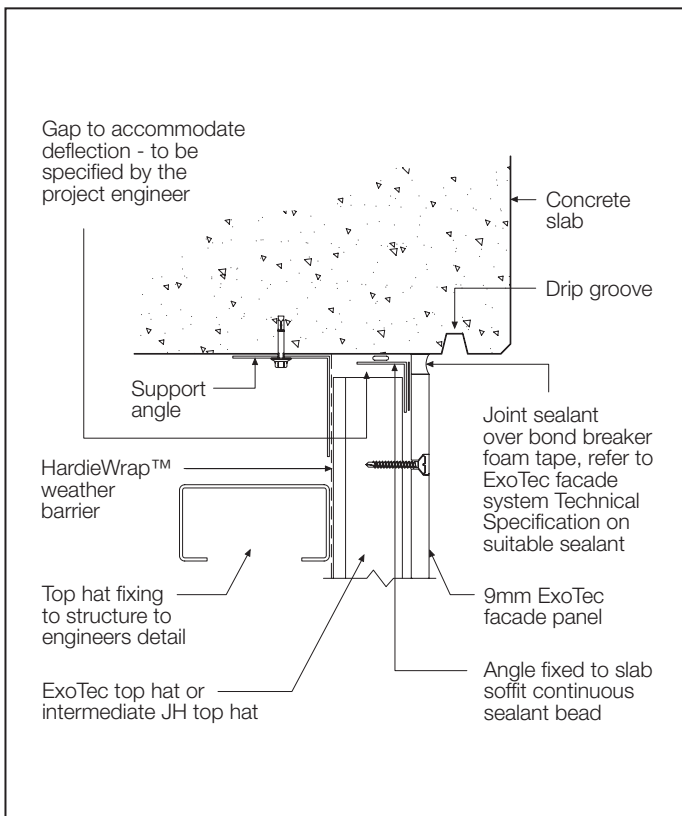

FIGURE 15 WALL DEFLECTION UNDER SLAB

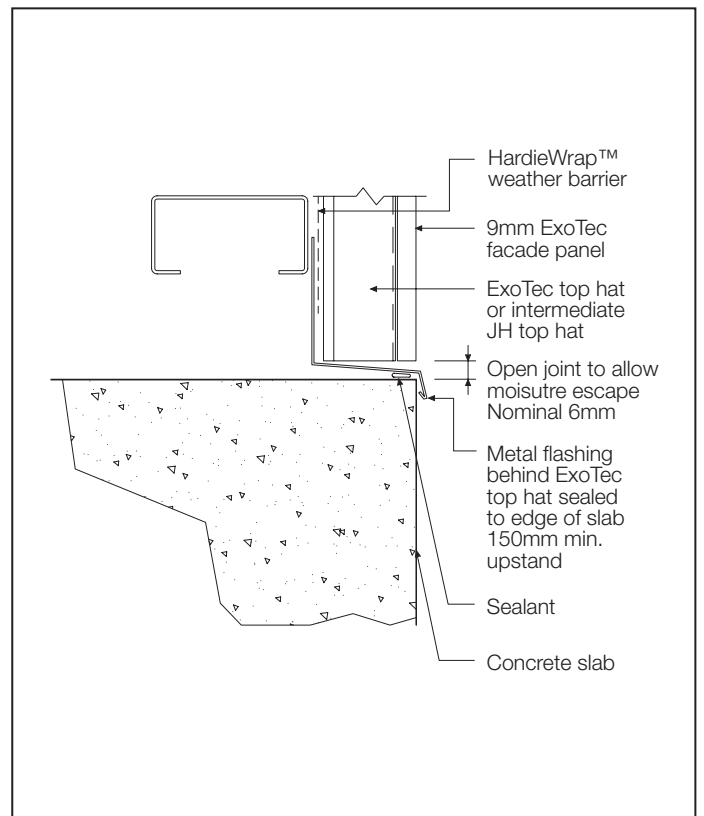

FIGURE 17 WALL BASE TYPICAL DETAIL 2

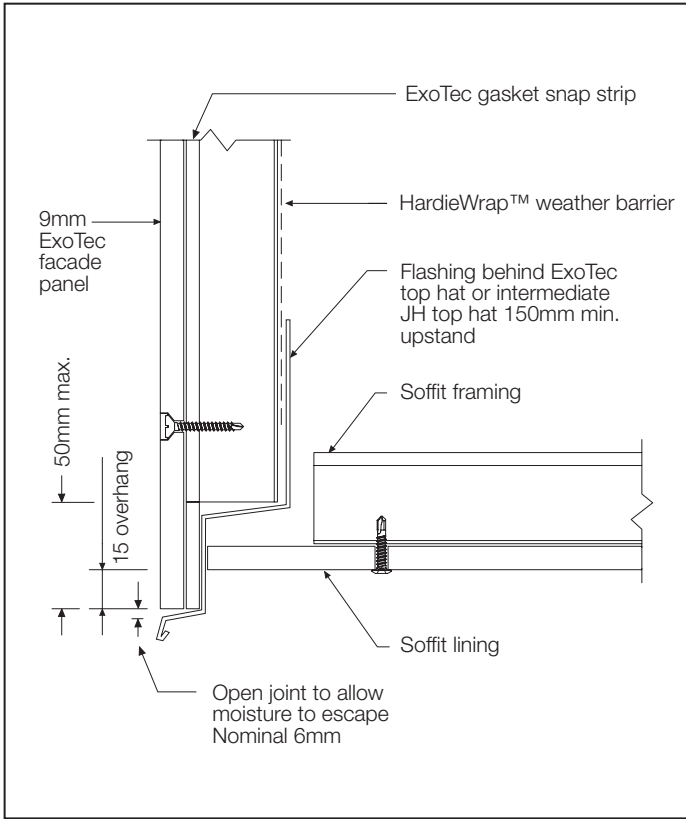

FIGURE 18 TYPICAL SOFFIT DETAIL

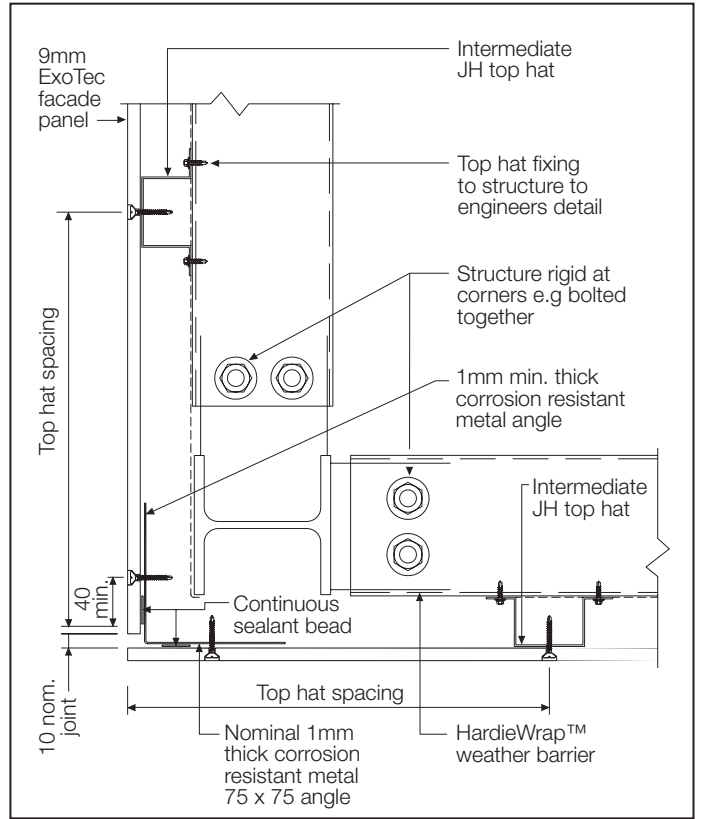

FIGURE 20 EXTERNAL CORNER DETAIL

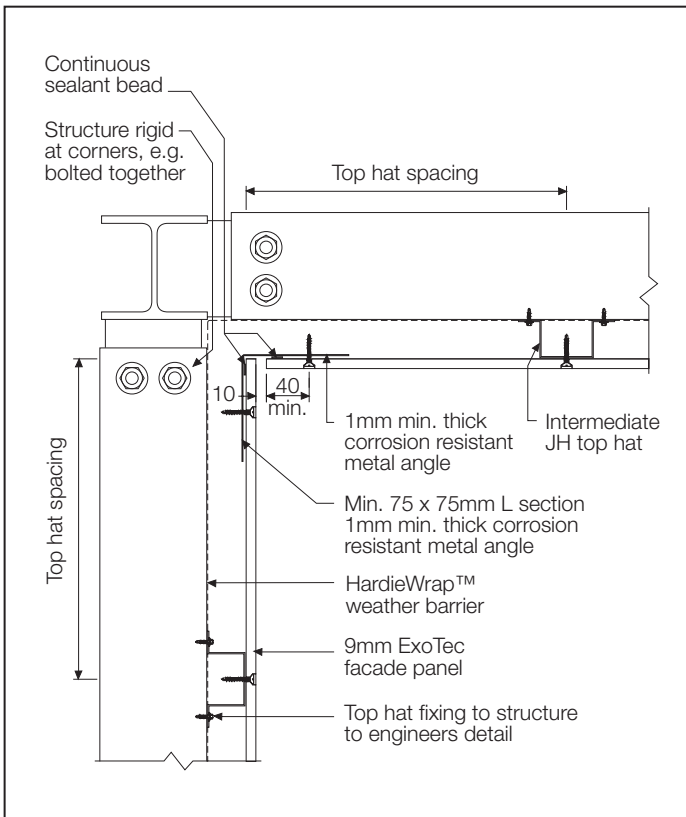

FIGURE 19 INTERNAL CORNER DETAIL

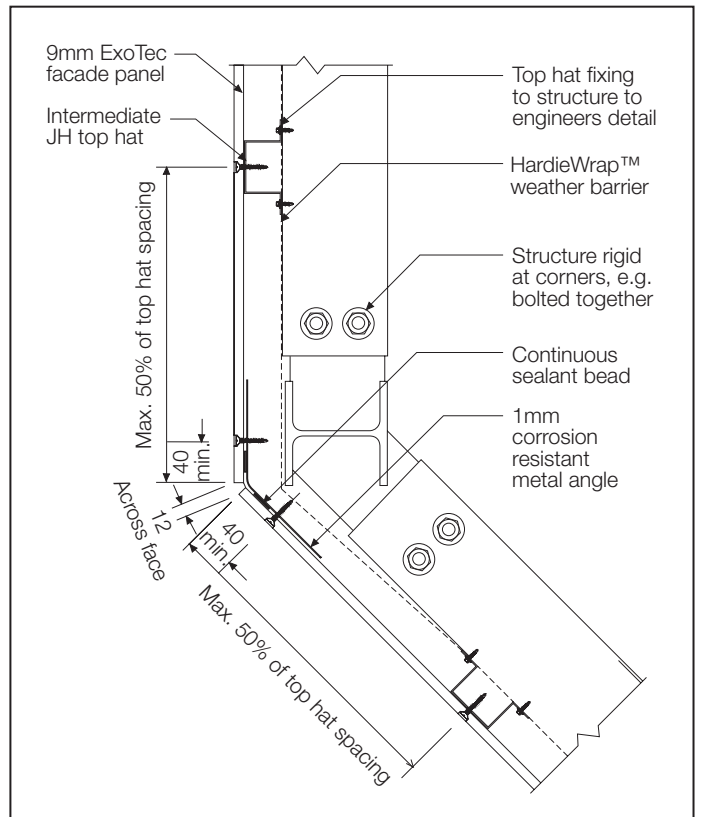

FIGURE 21 NON SQUARE EXTERNAL CORNER

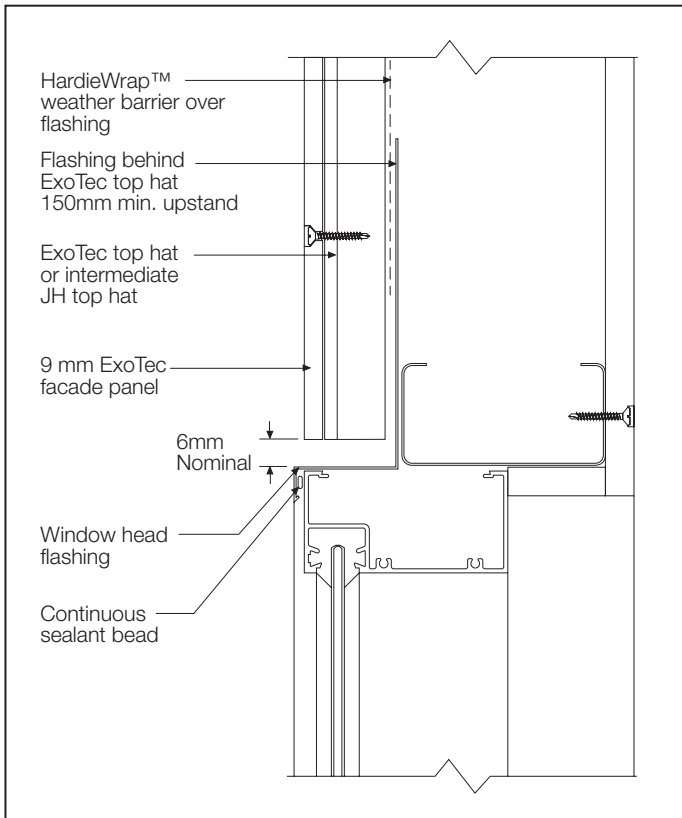

FIGURE 22 WINDOW HEAD DETAIL

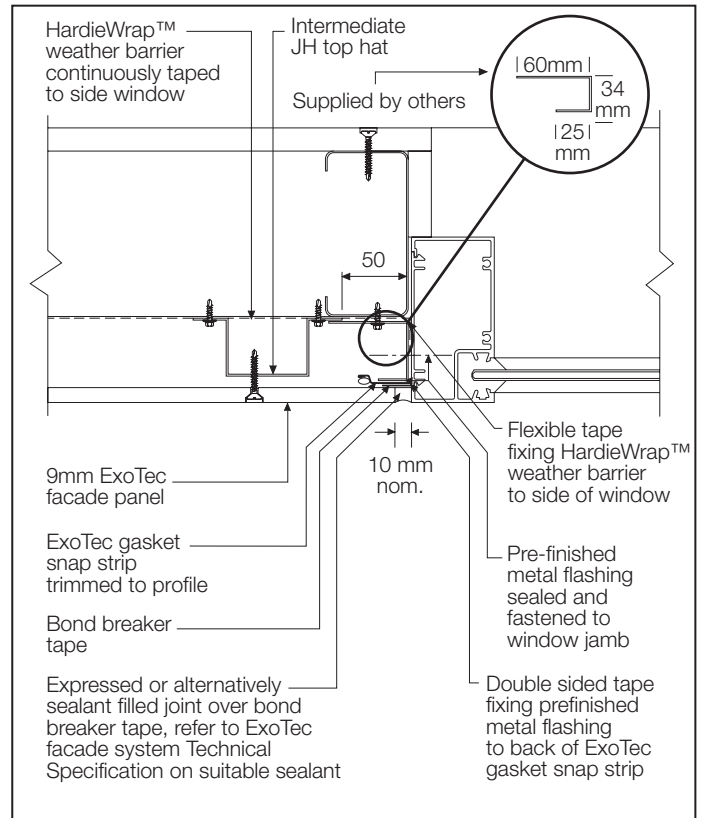

FIGURE 24 WINDOW JAMB SECTION

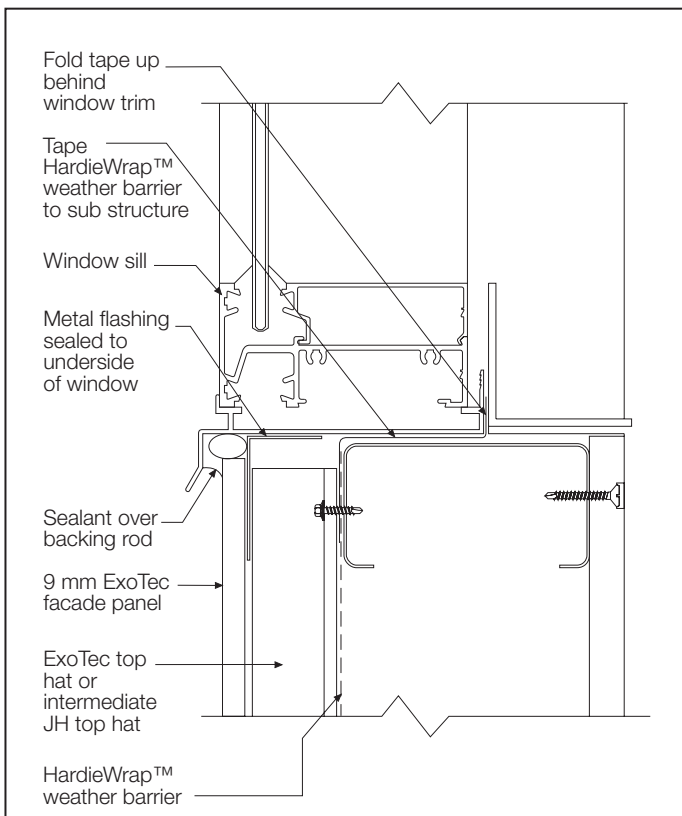

FIGURE 23 WINDOW SILL DETAIL

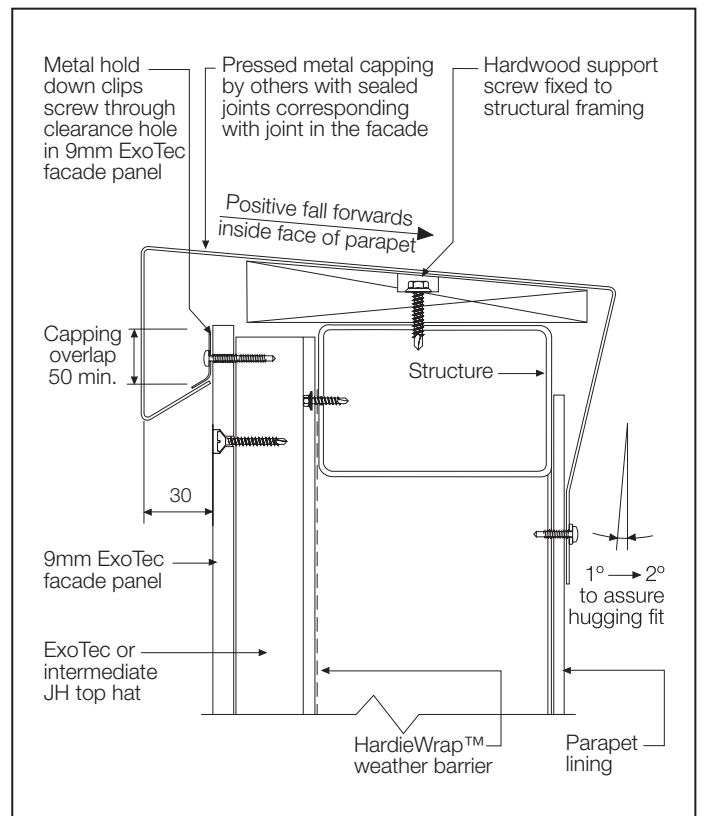

FIGURE 25 PARAPET CAPPING DETAIL 1

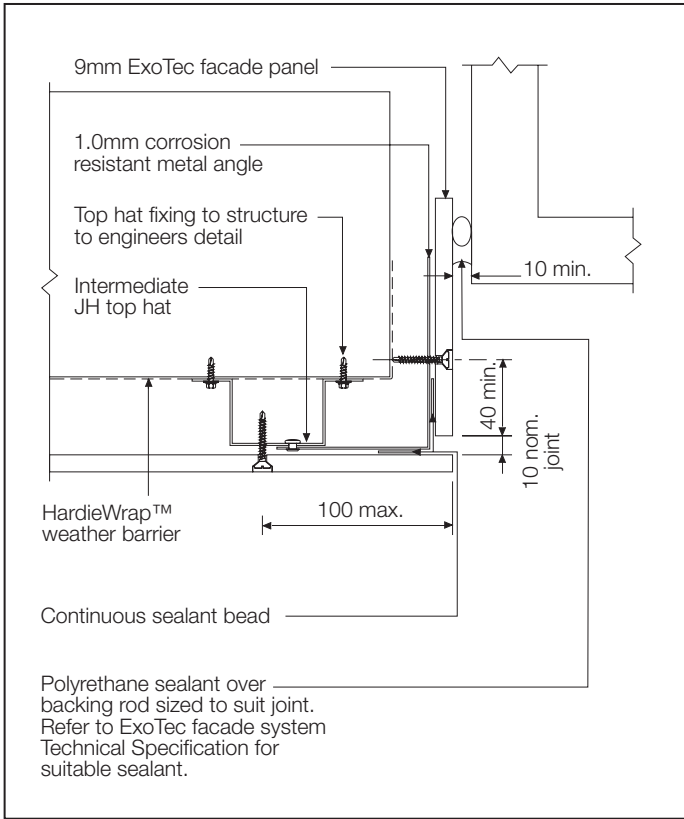

FIGURE 26 PLAN VIEW: STEP FLASHING TO MASONRY WALL

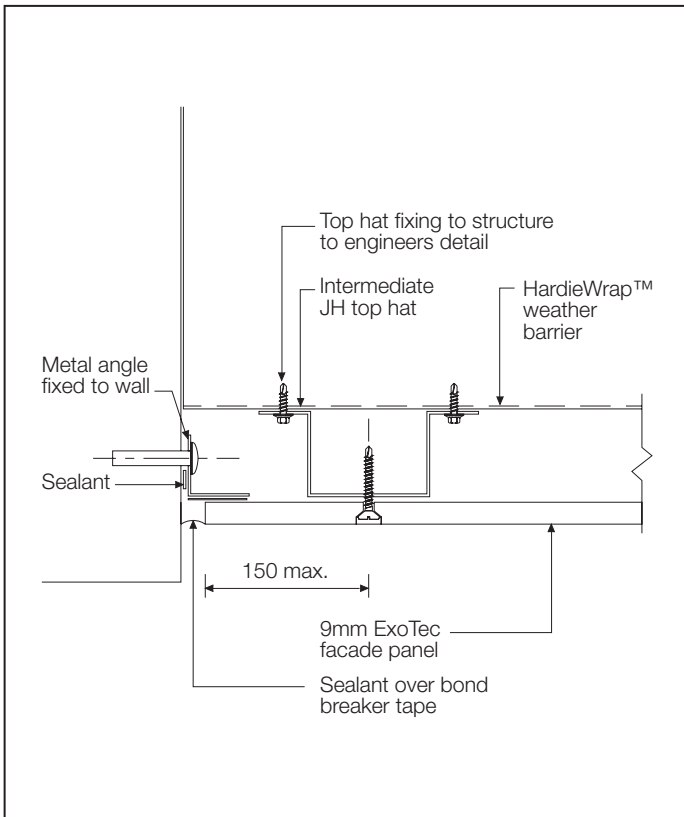

FIGURE 27 PLAN VIEW: ABUTTING TO A MASONRY WALL

15 WARRANTY

ExoTec® facade panel

10 YEAR WARRANTY

January 2012

James Hardie Australia Pty Limited (“James Hardie”) warrants to the first purchaser of ExoTec® facade panel (**Product**) from James Hardie and the last purchaser of the Product prior to installation that, subject to compliance with the Conditions of Warranty below:

- for a period of 10 years from the date of purchase, the Product will be free from defects due to defective factory workmanship or materials; and
- for a period of 10 years from the date of purchase, the Product will be resistant to damage from cracking, moisture, rotting, fire and termites to the extent set out in James Hardie’s relevant published literature current at the time of installation; and
- for a period of 12 months from the date of purchase that the accessories supplied by James Hardie will be free from defects due to defective factory workmanship or materials.

For the purposes of this warranty, a “defect” in respect of the Product means a non-compliance with AS/NZS 2908.2:2000 Cellulose-cement products - Flat sheet.

CONDITIONS OF WARRANTY

This warranty is strictly subject to the following conditions:

- (a) James Hardie will not be liable for breach of this warranty unless the claimant provides proof of purchase of the Product and makes a written claim to James Hardie at the address set out below, either within 30 days after the defect would have become reasonably apparent or, if the defect was reasonably apparent prior to installation, then the claim must be made prior to installation.
- (b) the Product is subject to natural variation in finish as part of the manufacturing process. The builder/installer must ensure the Product meets aesthetic requirements before installation. Subject to the terms of this warranty, after installation of the Product, James Hardie is not liable for claims arising from aesthetic surface variations if such variations were, or would upon reasonable inspection have been, apparent prior to installation;
- (c) this warranty cannot be relied upon by any other person and is not transferable;
- (d) the Product must be installed and maintained strictly in accordance with the relevant James Hardie literature current at the time of installation and must be installed in conjunction with the components or products specified in the literature. To obtain copies of such literature go to or contact Ask James Hardie™ on 13 11 03. Further, all other products, including coating and jointing systems, applied to or used in conjunction with the Product must be applied or installed and maintained strictly in accordance with the relevant manufacturer’s instructions and good trade practice;
- (e) the project must be designed and constructed in strict compliance with all relevant provisions of the current Building Code of Australia, regulations and standards;
- (f) if the claimant chooses to rely upon this warranty then the claimant’s sole remedy under this warranty for breach of this warranty is (at James Hardie’s option) that James Hardie will either supply replacement Product, rectify the affected Product or pay for the cost of the replacement or rectification of the affected Product;
- (g) In the circumstances where the Australian Consumer Law does not apply in respect of the purchase of the Product, James Hardie will not be liable for any losses or damages (whether direct or indirect) including property damage or personal injury, consequential loss, economic loss or loss of profits, arising in contract or negligence or howsoever arising. Without limiting the foregoing, James Hardie will not be liable for any claims, damages or defects arising from or in any way attributable to poor workmanship, poor

design or detailing, settlement or structural movement and/or movement of materials to which the Product is attached, incorrect design of the structure, acts of God including but not limited to earthquakes, cyclones, floods or other severe weather conditions or unusual climatic conditions, efflorescence or performance of paint/coatings applied to the Product, normal wear and tear, growth of mould, mildew, fungi, bacteria, or any organism on any Product surface or Product (whether on the exposed or unexposed surfaces);

- (h) In the circumstances where the Australian Consumer Law does not apply in respect of the purchase of the Product, all warranties, conditions, liabilities and obligations other than those specified in this warranty are excluded to the fullest extent allowed by law;
- (i) If meeting a claim under this warranty involves re-coating of Product, there may be slight colour differences between the original and replacement Product due to the effects of weathering and variations in materials over time and James Hardie is not liable for any such colour differences;
- (j) In the circumstances where the Australian Consumer Law does not apply in respect of the purchase of the Product and therefore to this warranty, all expenses incurred as a result of claiming under this warranty are to be borne by the claimant.
- (k) In the circumstances where the Australian Consumer Law does apply in respect of the purchase of the Product and therefore to this warranty, if James Hardie accepts or it is determined by James Hardie that the claimant has a valid claim under this warranty, James Hardie will bear the claimant’s reasonable costs of claiming under this warranty. The claimant is responsible for all other costs of claiming under this warranty. All claims for such costs are to be notified to James Hardie at the address outlined below within 21 days from when the claimant first makes a claim under this warranty.

DISCLAIMER

The recommendations in James Hardie’s literature are based on good building practice but are not an exhaustive statement of all relevant information and are subject to conditions (d), (e), (g) and (h) above. Further, as the successful performance of the relevant system depends on numerous factors outside the control of James Hardie (e.g. quality of workmanship and design), James Hardie shall not be liable for the recommendations in that literature and the performance of the relevant system, including its suitability for any purpose or ability to satisfy the relevant provisions of the Building Code of Australia, regulations and standards.

IMPORTANT NOTE

If you acquire goods manufactured by James Hardie as a consumer according to the Australian Consumer Law, our goods come with guarantees that cannot be excluded under the Australian Consumer Law. You are entitled to a replacement or refund for a major failure and compensation for any other reasonably foreseeable loss or damage. You are also entitled to have the goods repaired or replaced if the goods fail to be of acceptable quality and the failure does not amount to a major failure.

Any rights a consumer may have under this warranty are in addition to other rights and remedies of a consumer under a law in relation to the goods to which this warranty relates. Nothing in this document shall exclude or modify any legal rights a customer may have under the Australian Consumer Law or otherwise which cannot be excluded or modified at law.

Contact details if you wish to make a claim under this warranty: For more information or to make a claim under this warranty please Ask James Hardie™ on 13 11 03, visit www.jameshardie.com.au or www.accl.com.au, email James Hardie via our website or write to James Hardie at:

James Hardie Australia Pty Ltd
10 Colquhoun Street Rosehill NSW 2142
PO Box 70 Parramatta NSW 2124

© Copyright 2012 James Hardie Australia Pty Ltd. ABN 12 084 635 558. ™ and ® denotes a trademark or registered mark owned by James Hardie Technology Limited

Ask James Hardie™
Call 13 11 03
www.jameshardie.com.au